

Montageanleitung

9901-A – Variante 1: Estrichboden

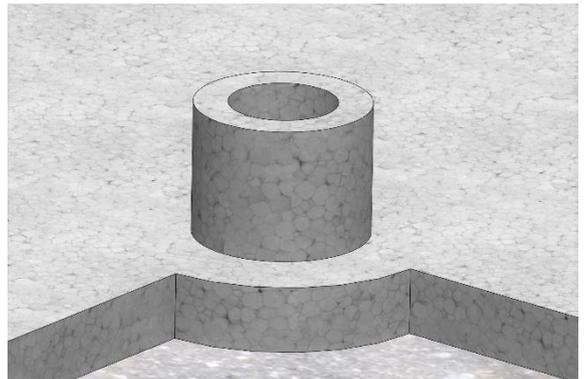

Die Kabel können seitlich oder von unten zugeführt werden (Darstellung: unten)



Styroporblock
ca. Durchmesser 130mm x Höhe 100mm

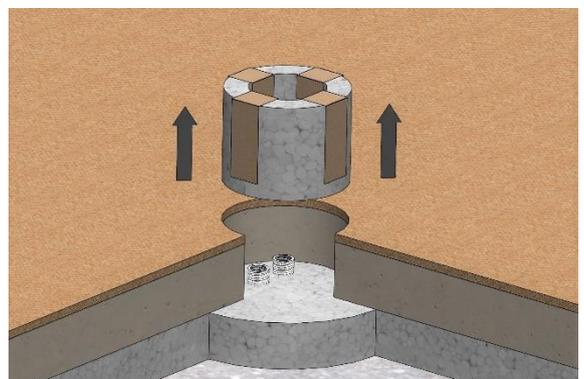
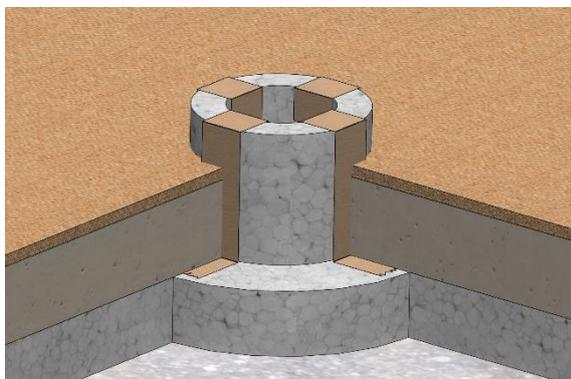
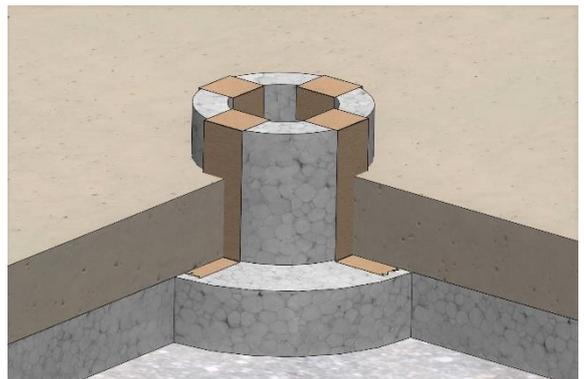
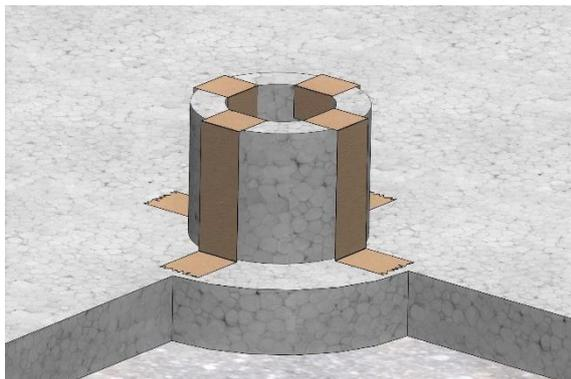

Montageanleitung

9901-A – Variante 1: Estrichboden

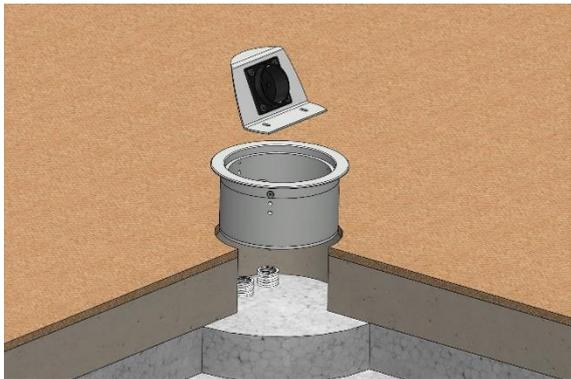

Geräteträger aus Dose herausnehmen

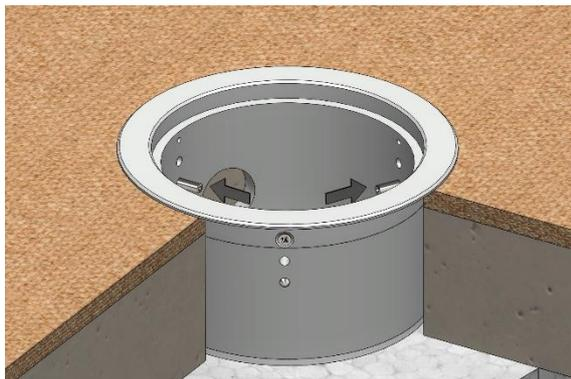
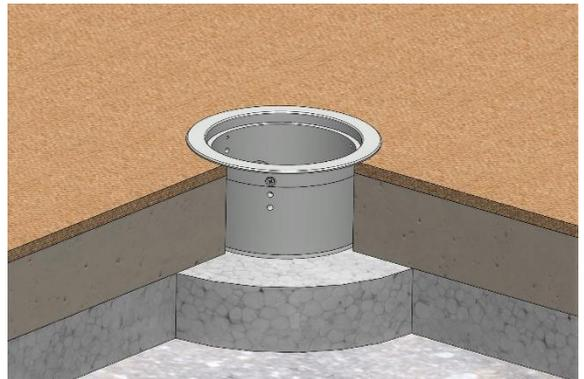

Dose mit den Stiftschrauben verankern

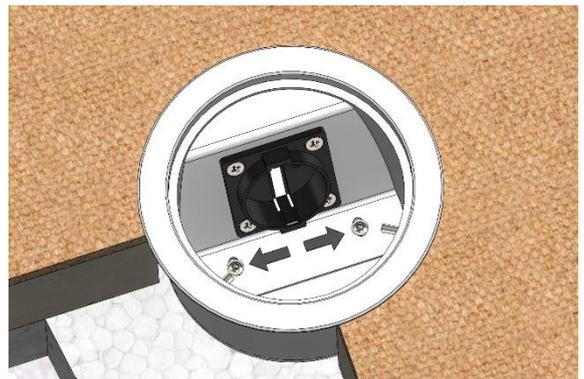

Geräte anschließen
Geräteträger festschrauben



Deckel kann mit Belag belegt werden



Montageanleitung

9901-A – Variante 2: Hohlboden



Bohren eines Loches mit 130mm Durchmesser

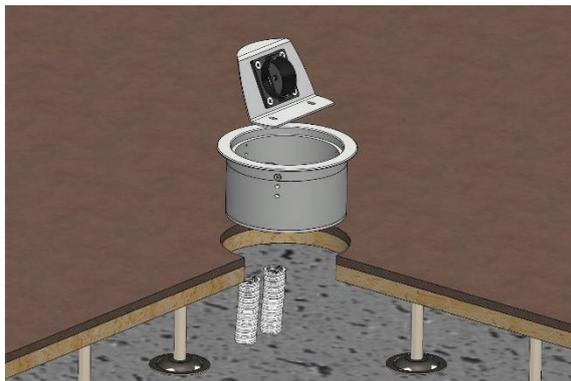

Geräteträger aus Dose herausnehmen

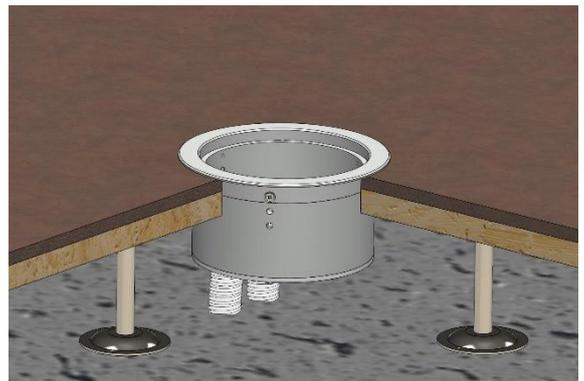

Kabel in die Dose einführen
Dose auf den Belag setzen

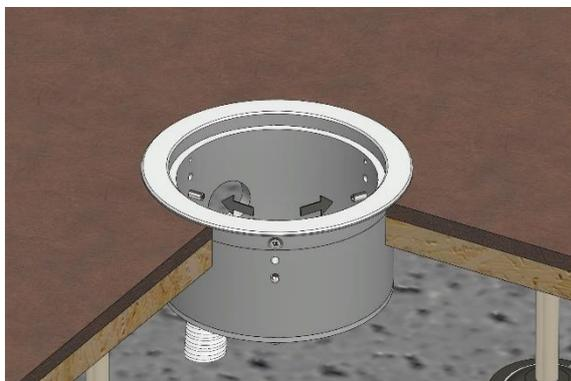

Dose mit Stiftschrauben verankern

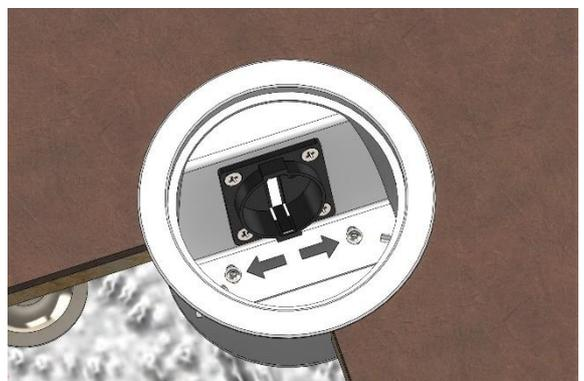

Geräte anschließen
Geräteträger befestigen

Montageanleitung

9901-A – Variante 2: Hohlboden

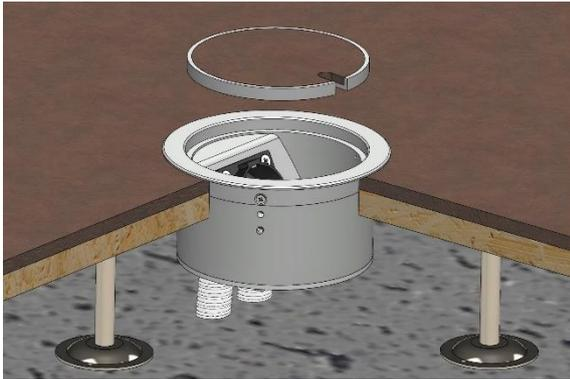

Deckel kann mit Belag belegt werden

