

NB 443  
2018.12.03  
Rev. 2.0

(NO)

(EN)

(SE)

# Bruksanvisning DCL Vegguttak

## User Guide DCL Wall Outlet

(Device for Connection of Luminaries) ELKO Plus, ELKO RS16

# Bruksanvisning DCL Väggtuttak

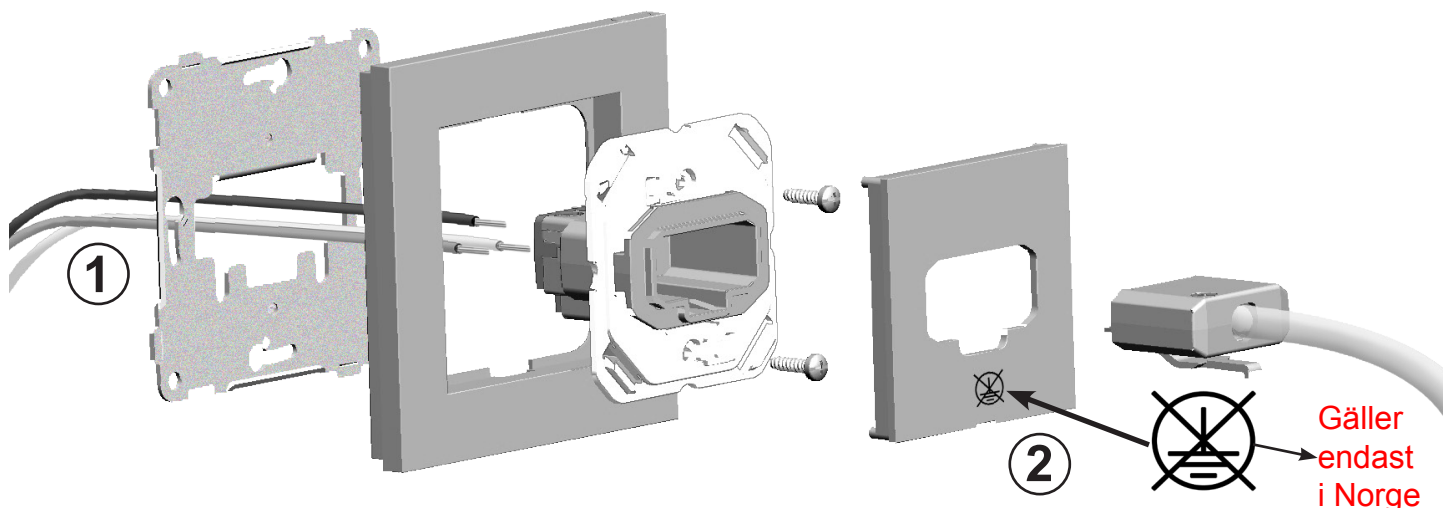

NB! Hvis produktet ikke jordes, skal det merkes med vedlagte symbolklistremerke:  plassert som vist på fig.2. OBS! Pass på at ledningene er trukket gjennom begge rammer som vist på fig.1.

**OBS! I Sverige så måste jorden anslutas. Enligt SS\_EN 61995-1 och -2.**

The absence of connected earth must be notified properly. Attach the enclosed symbol sticker:  as shown on fig.2. NOTE! Remember to draw the wiring through both frames as shown on fig.1.

Demontering av lokket / Demontering av locket/  
To release cover:

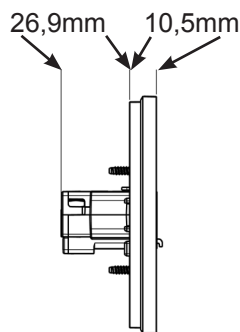
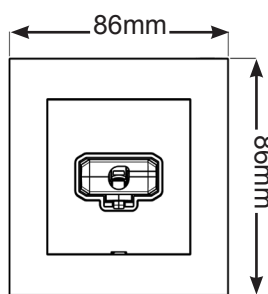
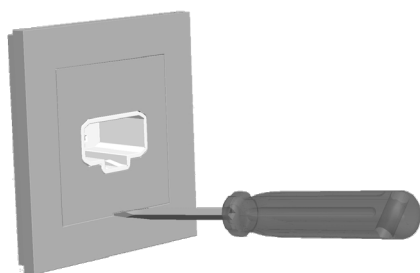

### Tekniske data / Technical Data:

Maks belastning/  
Max output: 6A  
Spenning/Voltage: 250V

## Terminering av plugg / Connecting the Plug:

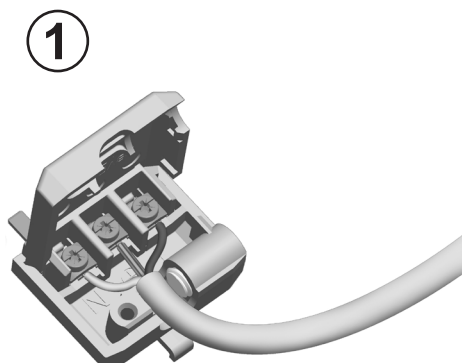

- ① Ledningene termineres.  
NB! Jording i midten.  
/Skruva fast ledarna.  
OBS! Jorden i mitten.  
/Connect electric wiring.  
NOTE! Earth in the middle.

- ② Lukk igjen lokket og skru fast.  
/Stäng locket och skruva fast.  
/Close the cover and screw tight.

- ③ Trekk til strekkavlaster med riktig moment.  
/Skruva fast dragavlastningen.  
/Tighten chord-anchor with correct torque pressure.

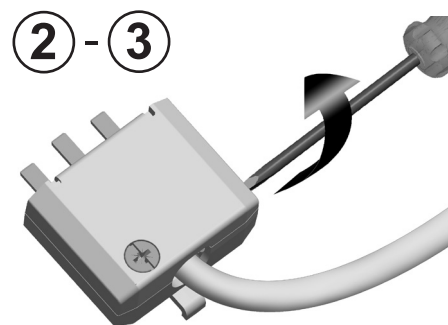

NB 443  
2018.12.03  
Rev. 2.0

NO

EN

SE

# Bruksanvisning DCL Takuttak

## User Guide DCL Ceiling Outlet

(Device for Connection of Luminaries)

# Bruksanvisning DCL Takuttag

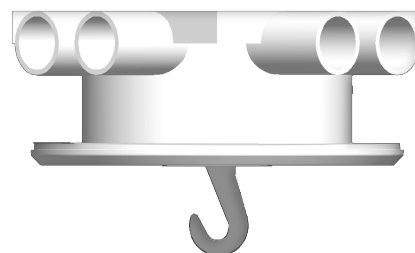
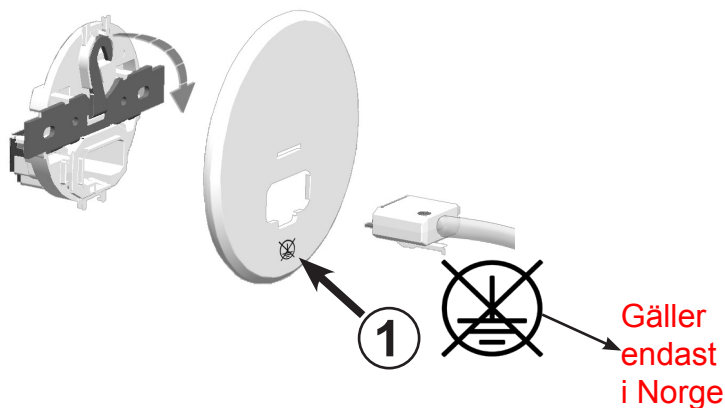

NB! Hvis produktet ikke jordes, skal det merkes med vedlagte symbolklistremerke:  plassert som vist på fig.1.

**OBS! I Sverige så måste jorden anslutas.**

**Enligt SS\_EN 61995-1 och -2.**

The absence of connected earth must be notified properly. Attach the enclosed symbol sticker:  as shown on fig.1.

DCL Takuttak kan monteres direkte i takbokser som er 40mm eller dypere.

DCL Takuttag kan monteres direkt i takdosa som är 40mm eller djupare.

DCL Ceiling Outlets can be assembled directly in flush mounting boxes that are 40mm or deeper.

Hvis takboksen er grunnere enn 40mm, må i tillegg en avstandsring (art.nr. 4975) benyttes. Dette må bestilles separat.

Vid takdosa grundare än 40mm, rekommenderas förhöjnings ram (E18 952 43). Beställs separat.

If the flush mounting box is shallower than 40mm, a spacer ring (Art. No. 4975) must be used. This must be ordered separately.

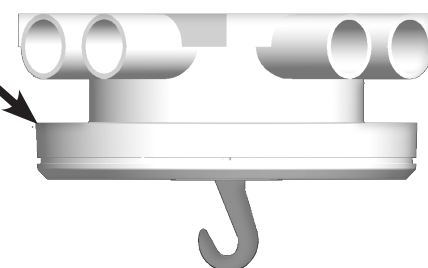
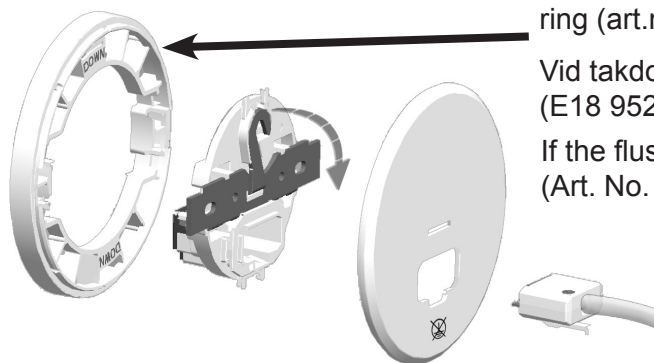

For demontering av lokket / För demontering av locket /  
To release cover:

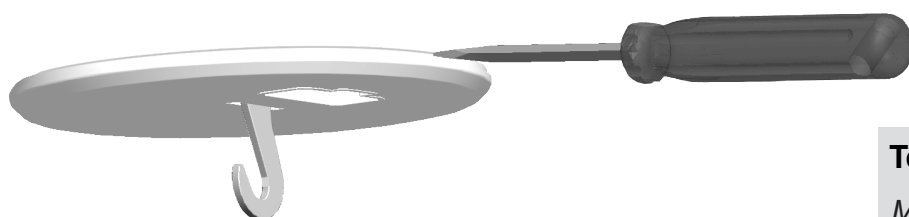

### Tekniske data / Technical Data:

Maks belastning/Max output: 6A  
Spending/Voltage: 250V