



DESIGNLIGHT

SCANDINAVIAN AB

DOWNLIGHT M-PENNY, FAST, 6-PACK

E-NR: 74 734 89

ART NR: MP-306MW

EFFEKT POWER	MATERIAL MATERIAL	KELVIN KELVIN	ARMATURFÄRG ARMATURE COLOR	ANSLUTNING CONNECTION	LUMEN (LM) LUMEN (LM)
6x7,4W	ALUMINIUM	3000K	MATT WHITE	230V	6x540LM

CE, ROHS, IP CERTIFIED BY SGS



- INKLUSIVE DRIVDON
- KOPPLINGSBOX FÖR FLEXRÖR
- LÅGT INBYGGNADSDJUP
- MONTERING KAN UTFÖRAS DIREKT MOT ISOLERING
- 6-PACK – PRISVÄRD

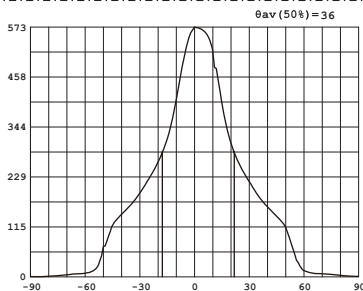
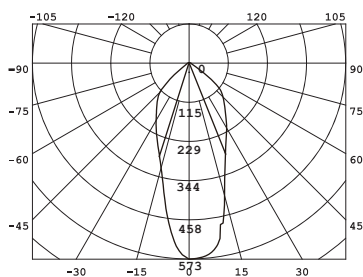

Avstånd	Belysningsstyrka	Spridnings vinkel 36°	Diam.
0.5m	1450.86lx 2284.31lx		35.88cm
1.0m	362.72lx 571.08lx		71.76cm
1.5m	161.21lx 253.81lx		107.64cm
2.0m	90.68lx 142.77lx		143.52cm
3.0m	40.35lx 63.45lx		215.28cm

1. Stäng av strömmen/Turn off the power

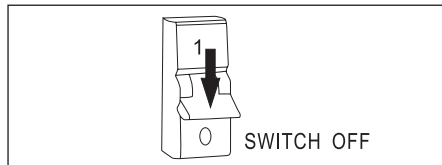

2. Borra hål i taket/Drill hole in ceiling

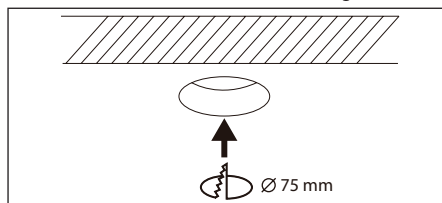

3. Anslut till LED-drivern/Connect to LED driver

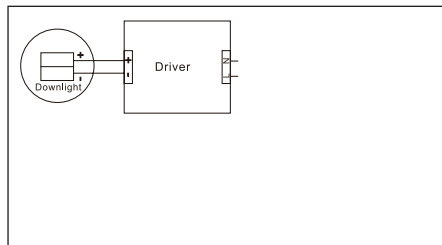

Mått/Dimension

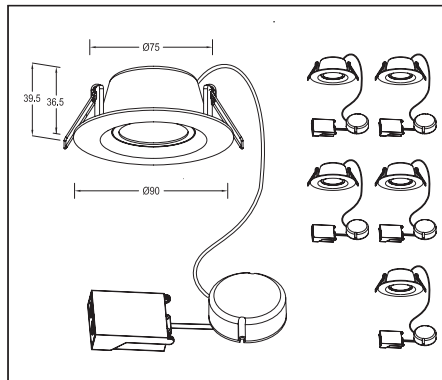

This luminaire contains built-in LED lamps.

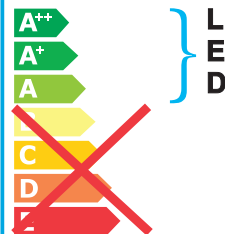

The lamps cannot be changed in the luminaire.

⚠ SÄKERHET:

1. Läs igenom hela manualen noggrant före installation.
2. Kontrollmät ALLTID diametern före håltagning i tak.
3. Kontrollera att drivdonet är anpassat för det antal lampor som ska installeras. Antal watt per lampa x antalet lampor ger storleken på transformator.
4. Försäkra dig om att spänningen är fränslagen före installation eller underhåll.
5. Installation ska utföras av behörig elektriker.
6. Ljuskällan är ej utbytbar. Hela armaturen måste bytas när ljuskällan är förbrukad.

⚠ SAFETY:

1. Read the entire manual carefully before installation.
2. ALWAYS check the diameter before drilling holes in the ceiling.
3. Check that the drive is adapted to the number of lamps to be installed. Number of watts per lamp x number of lamps gives the size of transformer.
4. Make sure that the voltage is switched off before installation or maintenance.
5. Installation must be performed by a qualified electrician.
6. The light source of this luminaire is not replaceable, when the light source reaches its end of life the whole luminaire shall be replaced.

1.900K	2.700-3.000K	4.000-4.500K	4.800K	5.000-5.000K	7.000-7.500K	10.000K
STEARINLJUS CANDLE	VARMVIT WARM WHITE	NATURLIG VIT NATURAL WHITE	SOLLJUS DIRECT SUN	VITT DAGSLJUS DAY WHITE	KALLVIT COOL WHITE	BLÅ HIMMEL BLUE SKY

DESIGNLIGHT
SCANDINAVIAN AB

DESIGNLIGHT SCANDINAVIAN AB · TOFFELVÄGEN 1 · 342 60 MOHEDA
KUNDCENTER: TELEFON 0472-716 10 · FAX 0472-716 09 · INFO@DESIGNLIGHT.NU · WWW.DESIGNLIGHT.NU