

Single-Channel Leading Edge Dimmer (416S and 425S)



Product description

The DIGIDIM 416S (16 Amp) and 425S (25 Amp) are wall-mounted single-channel leading edge (thyristor) dimmers. Both units also include a 16 A relay circuit.

Controllable by S-DIM, DMX, and Analogue, and fully DALI-compatible for use as Load Interface Units in a DIGIDIM lighting control system, the 416S and 425S can also function as standalone dimmers.

They can be connected to mains voltage lamps directly, or to low voltage lamps via a wire-wound transformer, and have a selectable, integral DALI power supply.

1. Unscrew screws A, B, C and D.

2. Remove the cover.

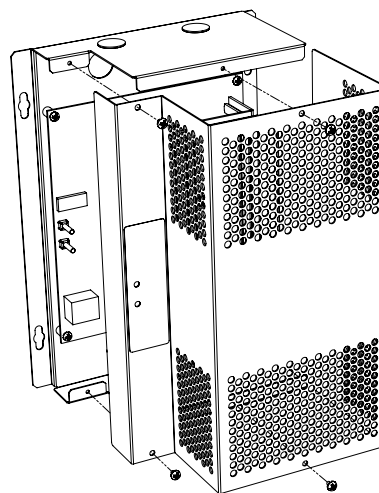
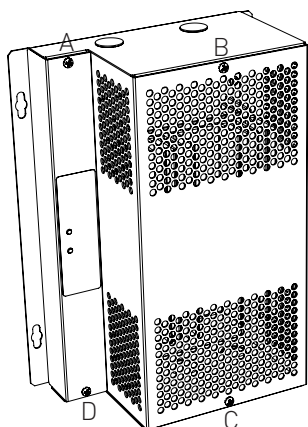

3. Remove the knockouts as required.

Knockouts: top (for control cables)

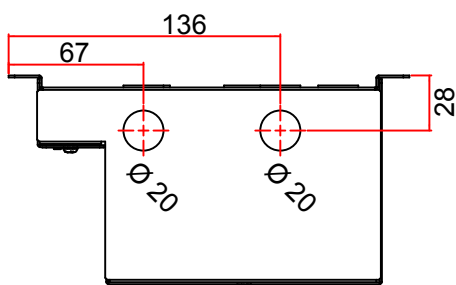

Knockouts: base (for power and output cables)

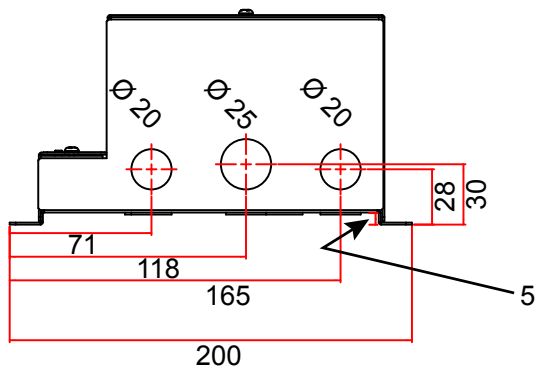

Knockouts: back

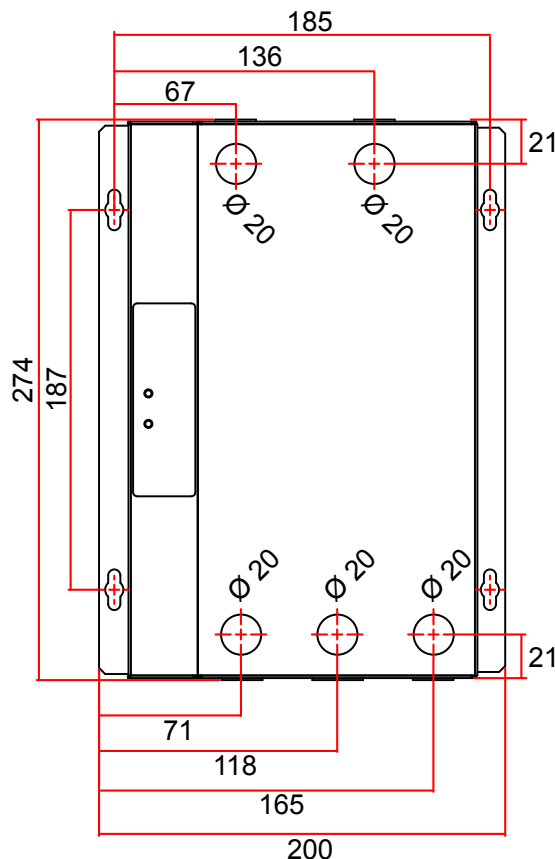

Contents

Section	Page
Product description	i
Mount to Wall	1
Electrical Installation	2
Mains Supply Input	3
Load outputs	3
Control inputs	3
DALI	3
Power Up	5
The 416S/425S Status Display (default display)	5
The 416S/425S Menu	6
Menu options	7
Technical Data	9

Mount to Wall

Mounting, Environmental and Clearance Requirements

Mounting

- Mount the chassis vertically on a flat surface.
- Use screws with a head diameter between 7 mm and 9 mm.
- Use wall plugs if necessary.
- Mount chassis on wall using 4 screws.

Environment

- The ambient temperature must be between 0 °C and 40 °C.
- Air humidity must be between 0 % and 90 % (non-condensing).
- The area must be adequately ventilated.
- Do NOT install this product in a damp location.

Clearance

- Make sure that enough space is left for ventilation: at 50 mm on each side of the unit. Refer to the mounting dimensions and clearance diagrams below.
- Leave sufficient clearance to allow cables and trunking to be connected.
- The grilles must NOT be obstructed.

Mounting dimensions and clearance (mm)

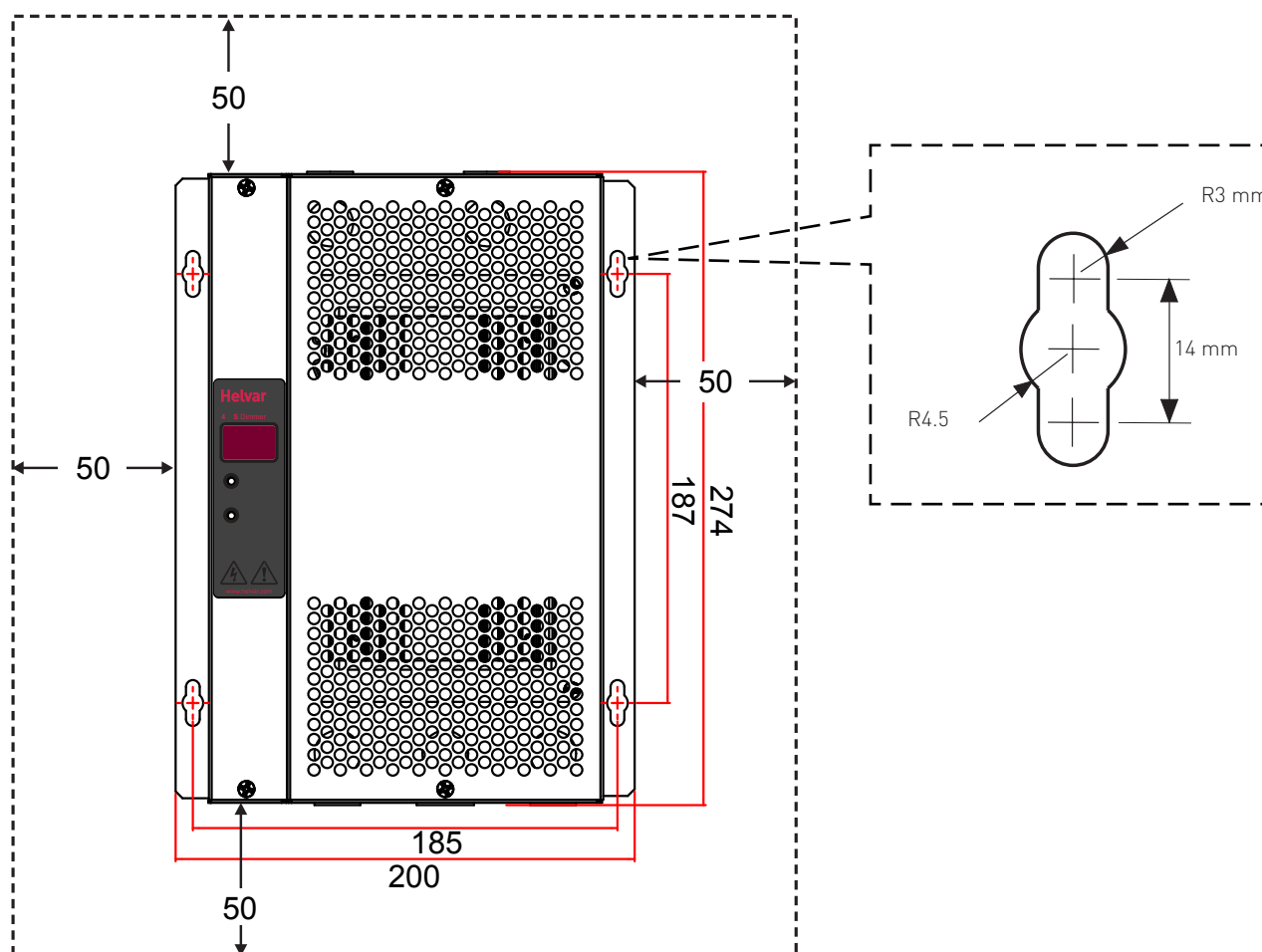

Electrical Installation

WARNING: BEFORE COMMENCING ANY ELECTRICAL WORK, ISOLATE THE ELECTRICITY SUPPLY AT THE MAIN DISTRIBUTION BOARD.

Connections

With the cover removed, connect the earth, mains power, and the control wiring (see details below)

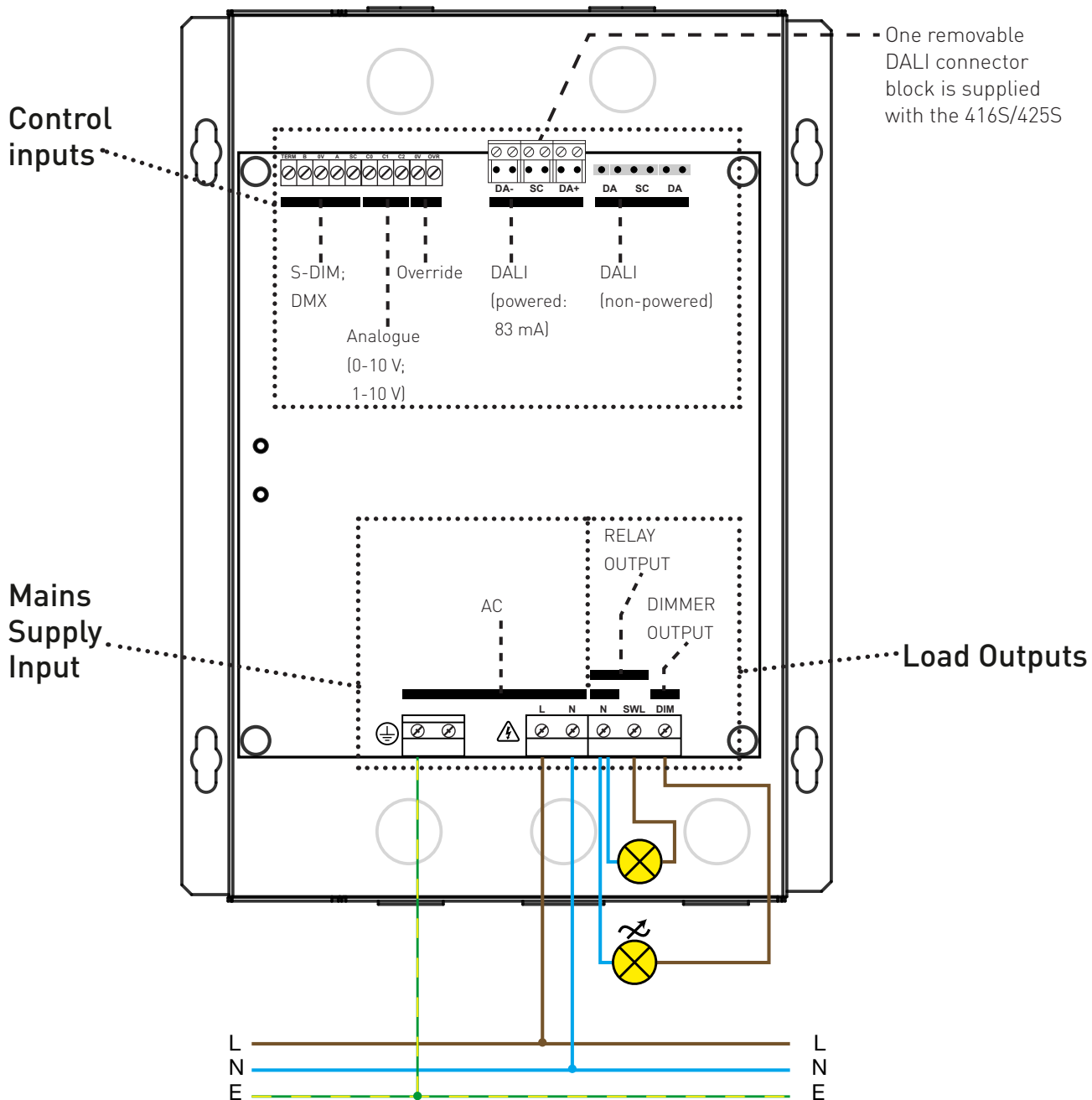

Cable access

Use the knock-outs for cable access. The gap between the back of the case and the wall may be used for cable entry.

Mains Supply Input

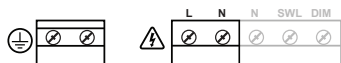

WARNING: THE SUPPLY INPUT EARTH MUST BE CONNECTED.

Load outputs

Dimmer output



Relay output (Switched load)



Control inputs

Control input connection terminals are screw terminals. These control inputs can be connected to the 416S/425S:

DALI (non-powered) Powered DALI (83 mA) Analogue signal S-DIM DMX	} Connect only one of these control inputs to the 416S/425S at one time.
Override	
The Override input can be connected in addition to any of the other inputs. If the Powered DALI (83 mA) connection is used, the override input must be treated as potentially live.	

DALI

One DALI connector block is supplied with the 416S/425S. Connect DALI wires to the connector block, and then attach the block to one of the DALI terminals (powered or non-powered).

Powered DALI:

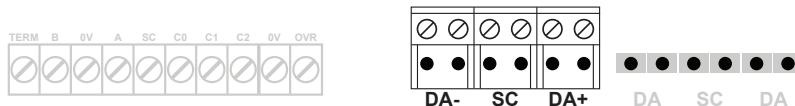

If the built-in 83 mA DALI power supply is required, use the powered DALI connection.

The powered DALI connection is not isolated from the other control outputs.

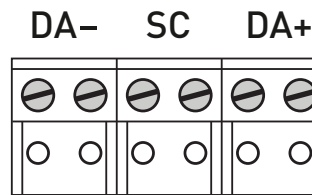

DA-: DALI -
 SC: Screen
 DA+: DALI +



To enable the DALI power connection:

Tighten ALL terminal screws (this internally links the terminal poles). Ensure correct polarity of DA- and DA+.

If adding another supply to the DALI network, make sure that you do not exceed the DALI power supply limit of 250 mA.

Non-powered DALI:



If the DALI network has an adequate power supply, use the non-powered DALI connection.

The non-powered DALI connection is isolated from the other control outputs.

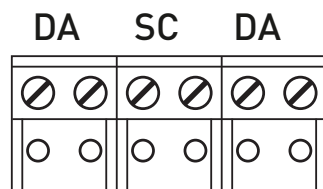

DA: DALI
 SC: Screen
 DA: DALI

S-DIM / DMX

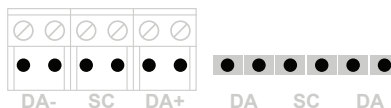

S-DIM/DMX termination

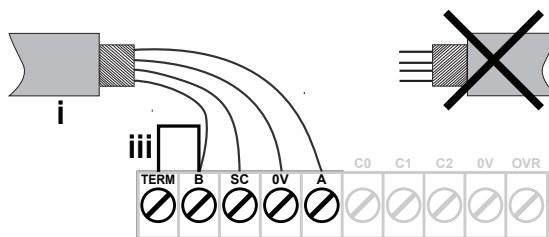
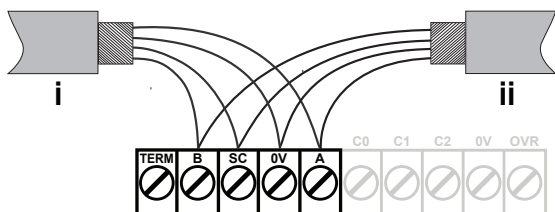

i = S-DIM or DMX Data Cable (from previous device)
 ii = S-DIM or DMX Data Cable (to next device)
 iii = Link for Termination (if unit is at end of S-DIM/DMX cable line)

Note: Keep unscreened wire lengths to a minimum

ANALOGUE:

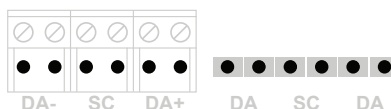
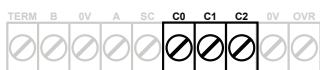

Typical analogue control circuits are shown below. One input only [0 – 10 V or 1 – 10 V] can be used at one time.

0 - 10 V (source)

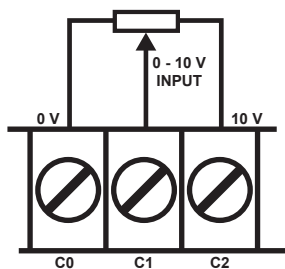

1 - 10 V (sink)

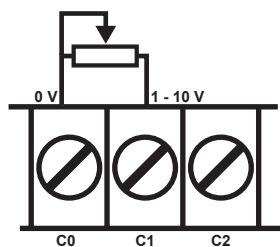

OVERRIDE:

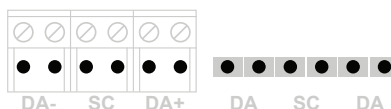

If the override input connection is short-circuited, e.g. by contact closure on an alarm system, the dimmer is set to its override level, regardless of external control signals.

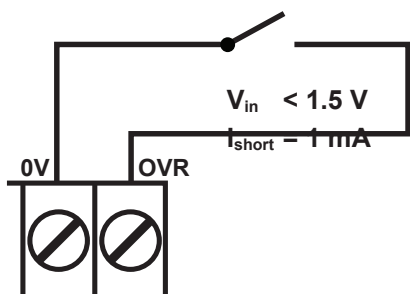

To provide output level override functionality, wire a switch between the '0 V' and 'OVR' terminals. Switch closure sets the light output of the dimmer channel to the override level.

The override level can be set using the interface (see section 5: The 416S/425S Menu) or Designer software.

If the Powered DALI (83 mA) connection is used, the override input must be treated as potentially live.

Power Up

During power up, the following sequence is displayed on the LED Control Panel.

Start-up Sequence:

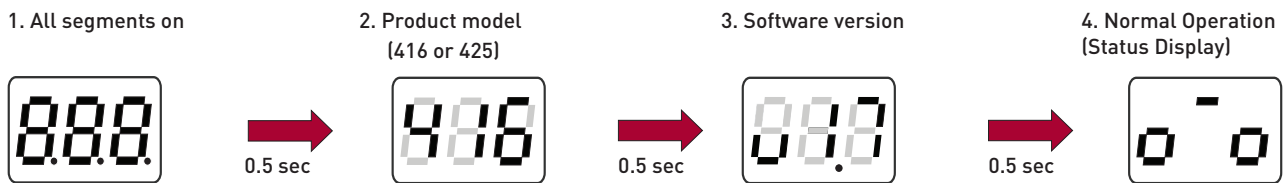

The 416S/425S Status Display (default display)

The Status display is the default view during operation.

The Status display shows:

- the relay (switched) level (left digit)
- the dimmer level (right digit)
- power and input / output indicators

You can view and directly adjust the relay and dimmed outputs from the status display.

Use the two push buttons (below the the display) to navigate the features menu and change parameters.

If neither of the buttons is pressed for 10 seconds, the Status display is shown.

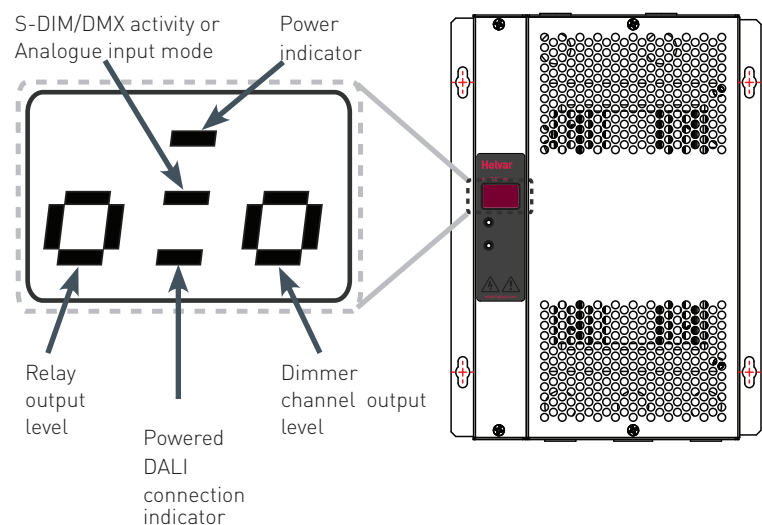

Key and LED Descriptions:

Relay (Switched)

This shows the following digits: **0** (0 % – 9 %), **1** (10 % – 19 %), **2** (20 % – 29 %), **3** (30 % – 39 %), **4** (40 % – 49 %), **5** (50 % – 59 %), **6** (60 % – 69 %), **7** (70 % – 79 %), **8** (80 % – 89 %), **9** (9 % – 99 %) and **F** (Full: 100 %).

Dimmer channel level

This shows the following digits: **0** (0 % – 9 %), **1** (10 % – 19 %), **2** (20 % – 29 %), **3** (30 % – 39 %), **4** (40 % – 49 %), **5** (50 % – 59 %), **6** (60 % – 69 %), **7** (70 % – 79 %), **8** (80 % – 89 %), **9** (9 % – 99 %) and **F** (Full: 100 %).

Power indicator

The power indicator (top segment of the middle digit) is always on when the 416S/425S is powered up.

S-DIM / DMX activity indicator

The S-DIM / DMX activity indicator (centre segment of the middle digit) is normally off, and flashes on intermittently to indicate S-DIM / DMX activity (communications).

Analogue

The centre segment of the middle digit flashes when Analogue mode is selected.

Software override indicator

The decimal point on the left is illuminated to indicate software override from the override test menu.

DALI power / activity indicator

The DALI indicator (bottom segment of the middle digit) is off if there is no DALI power, and on if DALI power is present. If any DALI activity is directed to a channel within the device, the indicator blinks off.

Hardware (wired) override indicator

The side segments of the middle digit flash to indicate wired override.

The 416S/425S Menu

How to navigate the menu and configure the 416S/425S

Go to the next item in the main menu

Press and hold both buttons to step through the main menu options.

Select a menu option (access a submenu);

Select the next item in a submenu

When you have navigated to the main menu option that you want, press (and release) either of the buttons to access the submenu.
To step through the submenu items, press (and release) either of the buttons.

Adjust a value / parameter (from submenu);

Adjust a value / parameter (from main menu)

When you have selected an item in the submenu, to adjust that setting, press and hold one of the buttons.
The currently stored setting will show in non-flashing digits.
Options or values shown in flashing digits are not yet confirmed.
To confirm the new value / parameter, press and hold both buttons.
When you are in the main menu, to adjust the last viewed setting in a main menu option, press and hold one of the buttons.

Confirm (save) a setting

When you have adjusted a setting, press and hold both buttons to confirm the change (save the change to system memory)

Return to Status Display (default display)

If no button is pressed for 10 seconds, the Status Display is shown.
The Status Display shown here indicates that the Relay (switched) level is zero, and the level is zero.

Examples of adjusting settings

View and change switched and dimmer levels

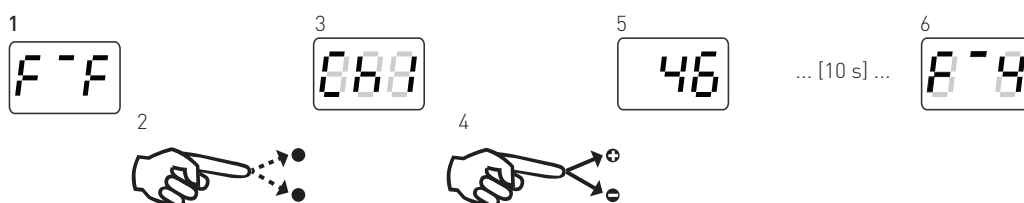

With the status display (1) showing, press either button once (2) to display REL or Chl (3). Press and hold the top or bottom button (4) to adjust the level.
When the required level is reached (5: this example shows 46 %), release the button.
After 10 seconds, the Status display is shown (6). The digit 4 indicates a dimmer channel level of 40 % – 49 %.

Set S-DIM or DMX address of the dimmer channel

When using S-DIM or DMX control, you can set a specific address for the relay (switched), dimmer, or both. The default address is 1.

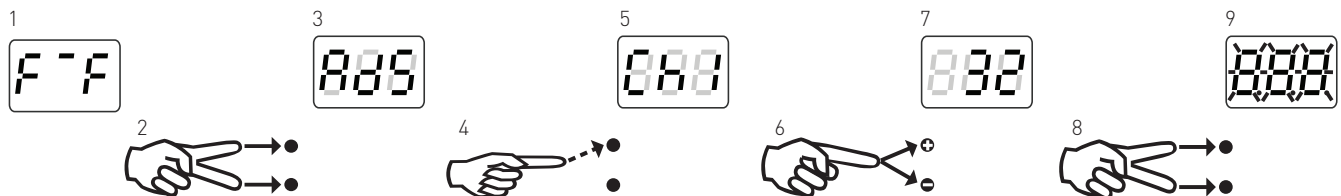

With the status display (1) showing, press and hold both buttons (2) to step through the menu.
When the display shows AdS (3), press the top button once (4) to display Chl.
When Chl is shown (5), press and hold one of the buttons (6) until the required address value is shown (7: this example is 32).
Press both buttons (8) to store the setting. The display flashes 888 when the value is stored (9).

Note 1: When the dimmed and relay channels are separated [ChP = SEP: see Channel Pairing in Menu Options], the base address option can be used to set both channel addresses at the same time.

Note 2: For DMX control input, enable DMX. For S-DIM control input, disable DMX. See Enable / Disable DMX in Menu Options.

Menu options

Navigate through the 416S/425S menus using the push buttons located below the display.

Main menu	Submenu	Options	Notes																											
Press and hold both buttons to step through	Press (and release) top/bottom button to enter and step through submenu	Press and hold top/bottom button to alter/select.																												
Status display																														
<p>Levels Left: Relay Right: Dimmer</p>		<table border="0"> <tr> <td>0: 0 % - 9 %</td> <td>6: 60 % - 69 %</td> </tr> <tr> <td>1: 10 % - 19 %</td> <td>7: 70 % - 79 %</td> </tr> <tr> <td>2: 20 % - 29 %</td> <td>8: 80 % - 89 %</td> </tr> <tr> <td>3: 30 % - 39 %</td> <td>9: 9 % - 99 %</td> </tr> <tr> <td>4: 40 % - 49 %</td> <td>F: 100 % (Full)</td> </tr> <tr> <td>5: 50 % - 59 %</td> <td></td> </tr> </table>	0: 0 % - 9 %	6: 60 % - 69 %	1: 10 % - 19 %	7: 70 % - 79 %	2: 20 % - 29 %	8: 80 % - 89 %	3: 30 % - 39 %	9: 9 % - 99 %	4: 40 % - 49 %	F: 100 % (Full)	5: 50 % - 59 %		<p>Set the output levels of the relay (switched) output [REI], Dimmer output [ChI], or both [ALL: available only when channels are not paired].</p> <p>Output levels: Left digit: Relay (switched) output Right digit: Dimmer</p>															
0: 0 % - 9 %	6: 60 % - 69 %																													
1: 10 % - 19 %	7: 70 % - 79 %																													
2: 20 % - 29 %	8: 80 % - 89 %																													
3: 30 % - 39 %	9: 9 % - 99 %																													
4: 40 % - 49 %	F: 100 % (Full)																													
5: 50 % - 59 %																														
S-DIM or DMX Address																														
		<p>S-DIM 1 - 254; Disabled (Default: 1) S-DIM base: 1 - 253</p> <p>DMX 1 - 512; Disabled (Default: 1) DMX base: 1 - 511</p>	<p>Set the S-DIM or DMX address of the relay (switched) output [REI], Dimmer output [ChI], or S-DIM / DMX base address [bAS].</p> <p>The base address option is available only when channels are not paired (ChP = SEP).</p>																											
DALI Address																														
		<p>DALI Address: 1 - 64; --- (=Removed); diS (=Disabled)</p> <p>DALI Base: 1 - 63 (Default: 1);</p>	<p>Set the DALI address of the relay (switched) output [REI], Dimmer output [ChI], or DALI base address [bAS].</p> <p>The base address option is available only when channels are not paired (ChP = SEP).</p> <p>If DALI status is --- (Removed), the next time that you connect it to a controller program or router, the DALI address will be re-allocated. If DALI status is diS (disabled), the address will not be re-allocated.</p>																											
DMX (Enable / Disable)																														
		<p>Off; On</p>	<p>Disable [Off] or enable [On] the DMX control input. For DMX control input, enable DMX. For S-DIM control input, disable DMX.</p>																											
Analogue																														
		<p>Off; 0.10; 1.10</p>	<p>Disable [Off] or enable Analogue control input: 0-10 V : source 1-10 V : sink</p>																											
Output type (dimmed output)																														
		<table border="1"> <thead> <tr> <th>Output</th> <th>Output type</th> <th>Control Protocol</th> </tr> </thead> <tbody> <tr> <td>t 0</td> <td>Non Dim</td> <td>All</td> </tr> <tr> <td>t 1</td> <td>Linear</td> <td>S-DIM / DMX</td> </tr> <tr> <td>t 2</td> <td>Square</td> <td>S-DIM / DMX</td> </tr> <tr> <td>t 3</td> <td>S-law</td> <td>S-DIM / DMX</td> </tr> <tr> <td>t 4</td> <td>DALI logarithmic</td> <td>DALI</td> </tr> <tr> <td>t 5</td> <td>DALI SSL</td> <td>DALI</td> </tr> <tr> <td>t 6</td> <td>DALI linear</td> <td>DALI</td> </tr> <tr> <td>t 7</td> <td>Analogue</td> <td>Analogue</td> </tr> </tbody> </table>	Output	Output type	Control Protocol	t 0	Non Dim	All	t 1	Linear	S-DIM / DMX	t 2	Square	S-DIM / DMX	t 3	S-law	S-DIM / DMX	t 4	DALI logarithmic	DALI	t 5	DALI SSL	DALI	t 6	DALI linear	DALI	t 7	Analogue	Analogue	<p>Notes on output types:</p> <p>Under S-DIM/DMX control, default is t 1</p> <p>Under DALI control, default is t 4</p> <p>Under Analogue control, default is t 7</p>
Output	Output type	Control Protocol																												
t 0	Non Dim	All																												
t 1	Linear	S-DIM / DMX																												
t 2	Square	S-DIM / DMX																												
t 3	S-law	S-DIM / DMX																												
t 4	DALI logarithmic	DALI																												
t 5	DALI SSL	DALI																												
t 6	DALI linear	DALI																												
t 7	Analogue	Analogue																												
Minimum fade time																														
		<p>1.00; 0.50; 0.15; 0.02 s (Default: 1.00 s)</p>	<p>Select the minimum fade time for the relay (switched) output [REI], Dimmer output [ChI] individually, or both channels [ALL].</p>																											
Channel pairing																														
		<p>P-1 (Paired) SEP (Separate = non-paired)</p>	<p>Unpair the relay (switched) output and dimmer output, so that they are adjusted separately (SEP), or pair them (P-1).</p>																											

Override level			
		0 – 100; --- (=not set)	Set override level for the relay (switched) output [REI], Dimmer output [ChI] individually, or both (ALL). If the override input connection is short-circuited, e.g. by contact closure on an alarm system, the relay and dimmer outputs are set to their override level, regardless of external control signals.
Override test			
		Off; On	Test the override mode [On] or deactivate override test [Off]. When the override test is running, the relay and dimmer outputs are set to their override level, regardless of external control signals, and the side segments of the central digit of the Status display will flash.
DALI minimum level (DALI mode only)			
		0.1; 1 – 100 %.	Set the minimum DALI lighting level for the relay (switched) output [REI], Dimmer output [ChI] individually, or both (ALL). Minimum DALI lighting level is the minimum level achieved when the load is turned on, no matter what scene is called or level is set. For example, if you set a minimum level of 50 % and call scene 4 (at 25% level), the channel output level will be 50 %.
Switch-on level (S-DIM / DMX mode only)			
		S-DIM 2 – 64% DMX 0.1; 1 – 64% [P-1 =Channels paired]	Set the switch-on level for the relay (switched) output [REI], Dimmer output [ChI] individually, or for both (ALL). The switched load or dimmed load (or both) will not turn on unless it receives a command to go to or above this level.
Maximum load level			
		1 – 100%. Default: 100%	Limit the maximum output level of the relay (switched) output [REI], Dimmer output [ChI] individually, or both (ALL).
Hysteresis			
			This setting affects the level at which the the relay (switched) output [REI], dimmer output [ChI], or for both (ALL) turn off. When hysteresis is on, the switch-off level is 80% of the switch-on level. At or below the switch-off level, the channel will be off. By default: - When hysteresis is on and the signal rises to 2 %, the load turns on; when it falls to 0 %, the load turns off. - When hysteresis is off (default setting) and the signal rises to 2 %, the load turns on; when it falls to 1 %, the load turns off.
SCR drive mode			
			Certain loads may need a different dimming method: tri: triac mode Scr: SCR mode Hyb: Hybrid mode (default)
Reset to defaults			
			To reset the 416S/425S to the original settings (defaults), press and hold one of the buttons for 10 seconds. Restoring factory settings returns all connected lighting to default levels immediately.

Technical Data

Connections

Power consumption:	1.3 W (with no output load)
Heat dissipation:	416S: 39 W with maximum load (resistive); 425S: 67 W with maximum load (resistive)
External protection:	The mains supply input must be externally protected by an MCB or fuse of a suitable rating. 416S: 16 A Type C MCB maximum 425S: 25 A Type C MCB maximum
Thermal protection:	Control board – resettable fuse Power devices – thermal sensing

Mains supply input

Connections (L, N, E):	Solid: $\geq 6 \text{ mm}^2$; Stranded: $\geq 4 \text{ mm}^2$
Terminal type:	Screw terminals
Mains supply voltage:	85 VAC to 264 VAC, 45 Hz to 65 Hz
Cable strip length:	8 mm

Control inputs

DALI connections:	1 \times DALI (standard, non-powered); 1 \times DALI powered (83 mA). DIGIDIM terminal block (one supplied with unit)
Cable type and size:	0.5 mm ² – 1.5 mm ² stranded or solid
Cable strip length:	6 mm
DALI consumption:	2 mA
DALI supply output:	Powered DALI: 83 mA (max.), 20 VDC (nominal)
DALI data transfer:	DALI standard IEC62386, with Helvar extensions

S-DIM / DMX inputs

Connections:	S-DIM and DMX use the same input connections
Terminal type:	Screw terminals
Cable type and size:	0.22 mm ² – 1.5 mm ² ; low-loss RS485 Type (multistranded, twisted and shielded). One twisted pair for A and B (85 Ω to 100 Ω impedance), one core or twisted pair for 0 V, and shield for screen. Example: Belden 8102 or Alpha 6222C
Cable strip length:	6 mm
Max. cable length:	100 m (low-loss cable)
S-DIM data transfer:	Helvar protocol (RS485, 115 kbps)
DMX data transfer:	DMX512-A protocol

Analogue input

Terminal type:	Screw terminals
Cable type and size:	2-wire; 0.22 mm ² – 1.5 mm ² (screened and twisted)
Max. cable length:	50 m

Override input

Terminal type:	Screw terminals
Cable type and size:	2-wire; 0.22 mm ² – 1.5 mm ² (screened and twisted)
Cable strip length:	6 mm
Max. cable length:	50 m
Voltage and current:	Input voltage: $V_{in} < 1.5 \text{ V}$; Short-circuit current $I_{short} = 1 \text{ mA}$

Load outputs

Terminal type:	Screw terminals
Cable type and size:	Solid: $\geq 6 \text{ mm}^2$; Stranded: $\geq 4 \text{ mm}^2$
Cable strip length:	8 mm

Relay output (switched load output)

Terminal type:	Screw terminals
Cable type and size:	Solid: $\geq 6 \text{ mm}^2$; Stranded: $\geq 4 \text{ mm}^2$
Cable strip length:	8 mm
Load current:	416S: 16 A; 425S: 16 A
Relay contacts:	High inrush

Mechanical data

Dimensions:	200 mm \times 274 mm \times 104 mm
Material:	Power coated steel (grey)
Mounting:	Vertical mounted, secured by four 'keyhole slots'
Weight:	416S: 2 kg; 425S: 2.6 kg
IP code:	IP20

Operating conditions

Ambient temperature:	0 $^{\circ}\text{C}$ to +40 $^{\circ}\text{C}$
Relative humidity:	Max. 90 %, non-condensing
Storage temperature:	-10 $^{\circ}\text{C}$ to +70 $^{\circ}\text{C}$

Conformity and standards

EMC emission:	EN 61000-6-3
EMC immunity:	EN 61547
Harmonics:	EN 61000-3-2* * May be subject to conditional connection for use above 16 A.
Safety:	EN 60950
Environment:	Complies with WEEE and RoHS directives