

# GD113S

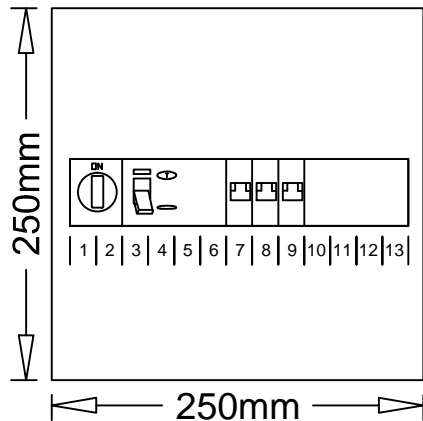

| POST | TYP     |
|------|---------|
| 1-2  | HA302S  |
| 3-6  | CDS425R |
| 7-9  | MCS110  |

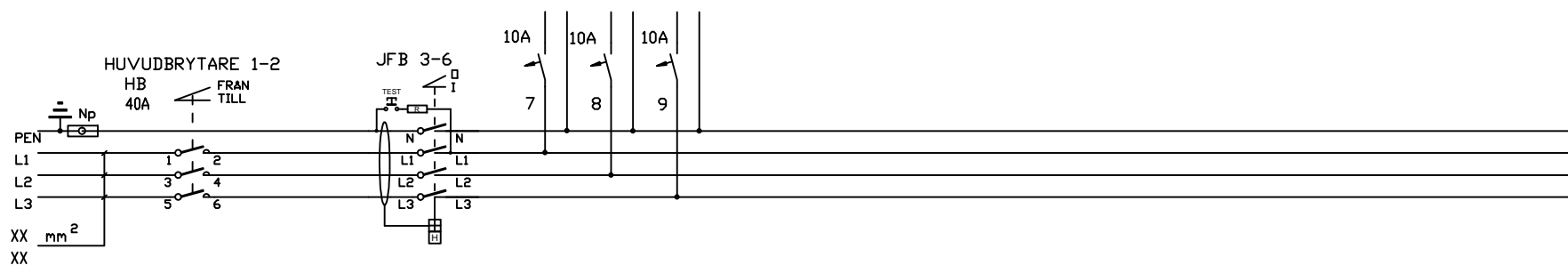

VID 5-LEDAR SYSTEM SKALL BYGEL MELLAN INKOMMANDE NOLLA OCH JORD DEMONTERAS

| Rev. | Datum      | Avser        | Datum  | Konstr.               | Ritad | Kontr. | Beteckning         |
|------|------------|--------------|--|-----------------------|-------|--------|--------------------|
| 3.0  | 2018-06-19 | ARTIKELLISTA | 2005-11-01   | MIKAEL HYLANDER       | MH    |        | GD113SF            |
|      |            |              | HAGER ELEKTRO AB<br>Box 9040<br>400 91 Göteborg<br>Tel:031-7063900 | HAGER STANDARDCENTRAL |       |        | Arb.nr<br>E2290830 |
|      |            |              |  |                       |       |        | Ritn.nr<br>3523B   |
|      |            |              |  |                       |       |        | Blad nr<br>1/1     |

# GD213S

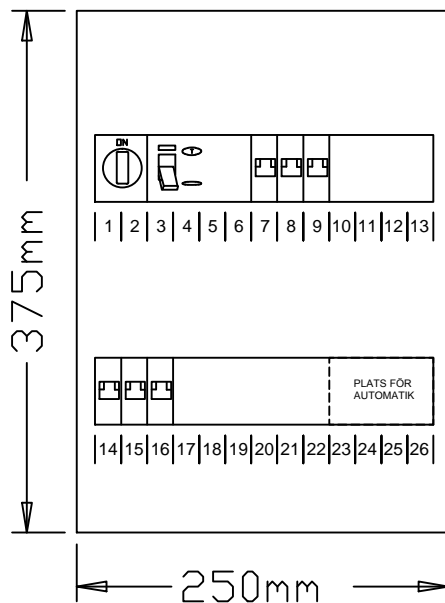

| POST  | TYP     |
|-------|---------|
| 1-2   | HA302S  |
| 3-6   | CDS425R |
| 7-9   | MCS110  |
| 14-16 | MCS110  |

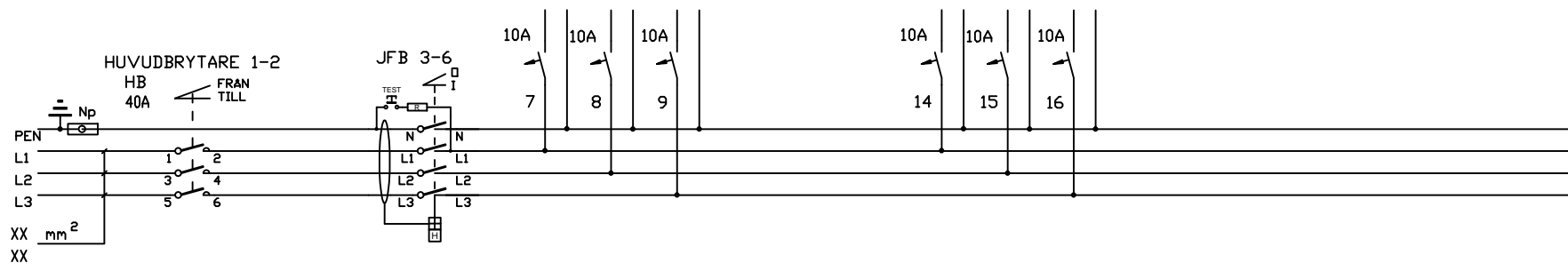

VID 5-LEDAR SYSTEM SKALL BYGEL MELLAN INKOMMANDE NOLLA OCH JORD DEMONTERAS

| Rev. | Datum      | Avser        | Datum  | Konstr.               | Ritad | Kontr. | Beteckning         |
|------|------------|--------------|--|-----------------------|-------|--------|--------------------|
| 3.0  | 2018-06-19 | ARTIKELLISTA | 2005-09-27   | MIKAEL HYLANDER       | MH    |        | GD213SF            |
|      |            |              | HAGER ELEKTRO AB<br>Box 9040<br>400 91 Göteborg<br>Tel:031-7063900 | HAGER STANDARDCENTRAL |       |        | Arb.nr<br>E2290831 |
|      |            |              |  |                       |       |        | Ritn.nr<br>3523AA  |
|      |            |              |  |                       |       |        | Blad nr<br>1/1     |

# GD313S

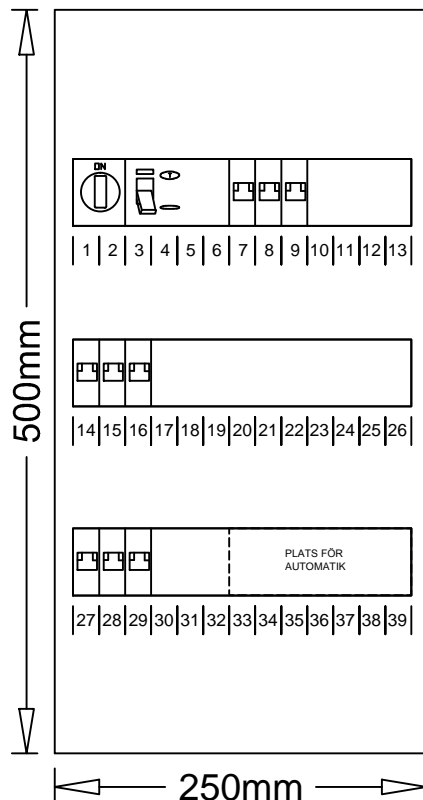

| POST  | TYP     |
|-------|---------|
| 1-2   | HA302S  |
| 3-6   | CDS425R |
| 7-9   | MCS110  |
| 14-16 | MCS110  |
| 27-29 | MCS110  |

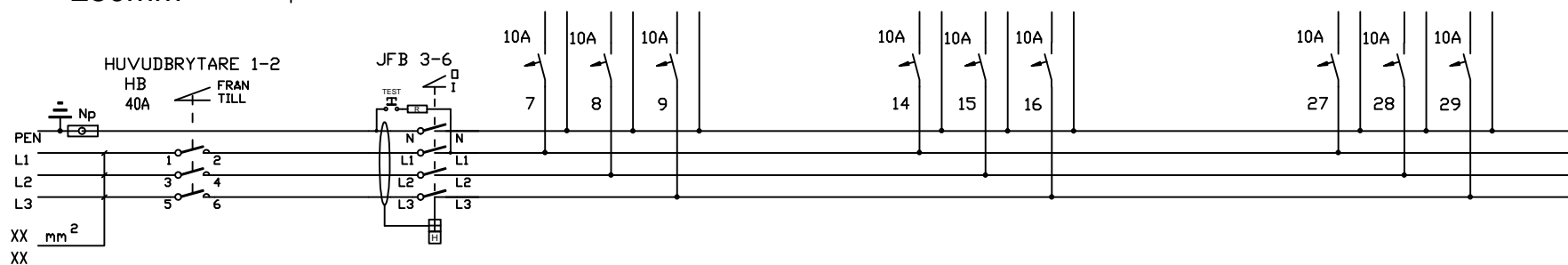

VID 5-LEDAR SYSTEM SKALL BYGEL MELLAN INKOMMANDE NOLLA OCH JORD DEMONTERAS

| Rev. | Datum      | Avser        | Datum  | Konstr.               | Ritad | Kontr. | Beteckning         |
|------|------------|--------------|--|-----------------------|-------|--------|--------------------|
| 3.0  | 2018-06-19 | ARTIKELLISTA | 2005-09-27   | MIKAEL HYLANDER       | MH    |        | GD313SF            |
|      |            |              | HAGER ELEKTRO AB<br>Box 9040<br>400 91 Göteborg<br>Tel:031-7063900 | HAGER STANDARDCENTRAL |       |        | Arb.nr<br>E2290832 |
|      |            |              |  |                       |       |        | Ritn.nr<br>3523C   |
|      |            |              |  |                       |       |        | Blad nr<br>1/1     |

# GD413S

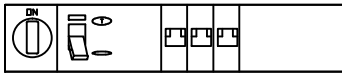

1 | 2 | 3 | 4 | 5 | 6 | 7 | 8 | 9 | 10 | 11 | 12 | 13



14 | 15 | 16 | 17 | 18 | 19 | 20 | 21 | 22 | 23 | 24 | 25 | 26

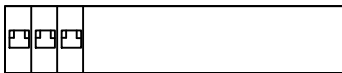

27 | 28 | 29 | 30 | 31 | 32 | 33 | 34 | 35 | 36 | 37 | 38 | 39

PLATS FÖR  
AUTOMATIK

40 | 41 | 42 | 43 | 44 | 45 | 46 | 47 | 48 | 49 | 50 | 51 | 52

625mm

250mm

| POST  | TYP     |
|-------|---------|
| 1-2   | HA302S  |
| 3-6   | CDS425R |
| 7-9   | MCS110  |
| 14-16 | MCS110  |
| 27-29 | MCS110  |

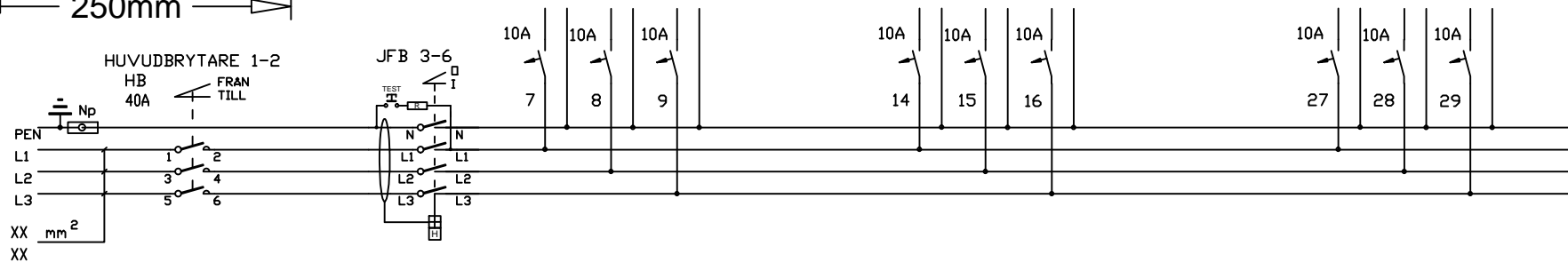

VID 5-LEDAR SYSTEM SKALL BYGEL MELLAN INKOMMANDE NOLLA OCH JORD DEMONTERAS

| Rev. | Datum      | Avser        | Datum  | Konstr.               | Ritad | Kontr. | Beteckning         |
|------|------------|--------------|--|-----------------------|-------|--------|--------------------|
| 3.0  | 2018-06-19 | ARTIKELLISTA | 2005-09-27   | MIKAEL HYLANDER       | MH    |        | GD413SF            |
|      |            |              | HAGER ELEKTRO AB<br>Box 9040<br>400 91 Göteborg<br>Tel:031-7063900 | HAGER STANDARDCENTRAL |       |        | Arb.nr<br>E2290833 |
|      |            |              |  |                       |       |        | Ritn.nr<br>3523D   |
|      |            |              |  |                       |       |        | Blad nr<br>1/1     |

# GD118S

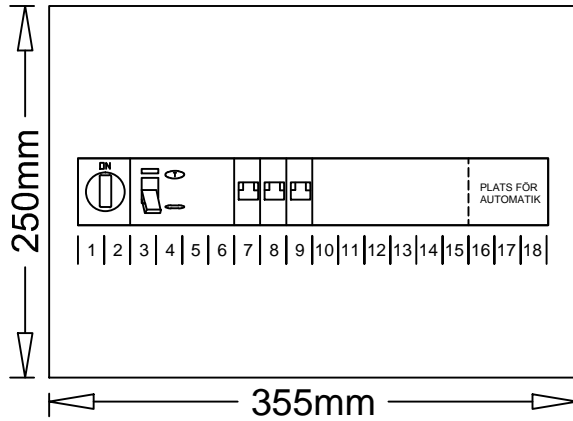

| POST | TYP     |
|------|---------|
| 1-2  | HA302S  |
| 3-6  | CDS425R |
| 7-9  | MCS110  |

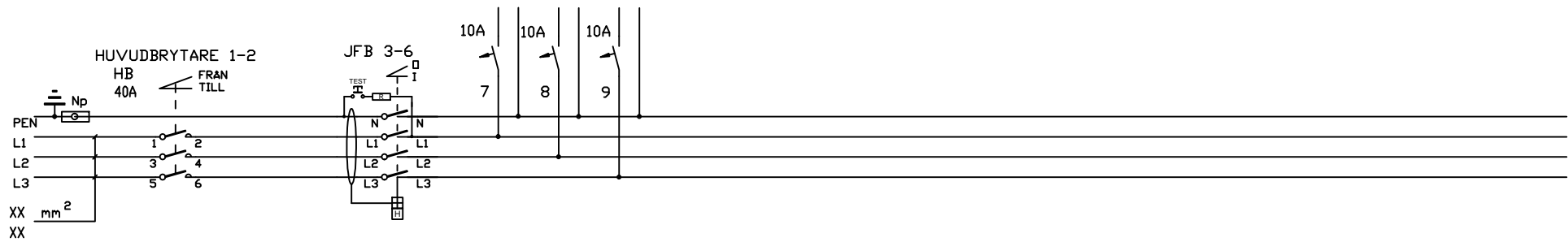

VID 5-LEDAR SYSTEM SKALL BYGEL MELLAN INKOMMANDE NOLLA OCH JORD DEMONTERAS

| Rev. | Datum      | Avser        | Datum  | Konstr.               | Ritad | Kontr. | Beteckning         |
|------|------------|--------------|--|-----------------------|-------|--------|--------------------|
| 3.0  | 2018-06-19 | ARTIKELLISTA | 2005-09-27   | MIKAEL HYLANDER       | MH    |        | GD118SF            |
|      |            |              | HAGER ELEKTRO AB<br>Box 9040<br>400 91 Göteborg<br>Tel:031-7063900 | HAGER STANDARDCENTRAL |       |        | Arb.nr<br>E2290838 |
|      |            |              |  |                       |       |        | Ritn.nr<br>3523H   |
|      |            |              |  |                       |       |        | Blad nr<br>1/1     |

# GD218S

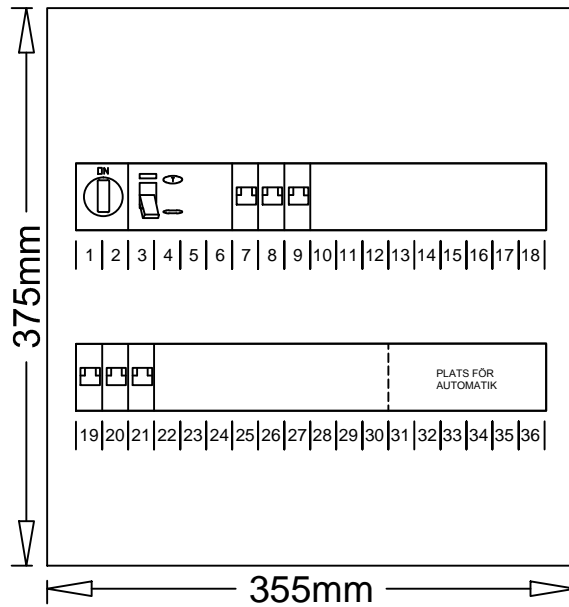

| POST  | TYP     |
|-------|---------|
| 1-2   | HA302S  |
| 3-6   | CDS425R |
| 7-9   | MCS110  |
| 19-24 | MCS110  |

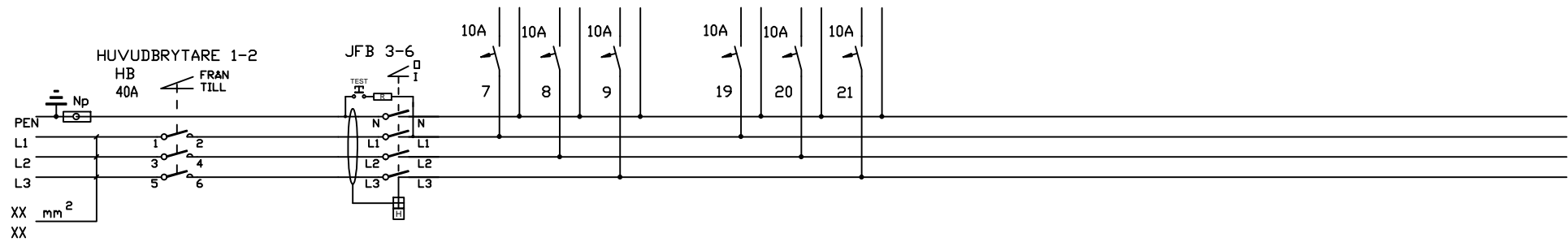

VID 5-LEDAR SYSTEM SKALL BYGEL MELLAN INKOMMANDE NOLLA OCH JORD DEMONTERAS

| Rev. | Datum      | Avser        | Datum  | Konstr.               | Ritad | Kontr. | Beteckning         |
|------|------------|--------------|--|-----------------------|-------|--------|--------------------|
| 3.0  | 2018-06-19 | ARTIKELLISTA | 2005-09-27   | MIKAEL HYLANDER       | MH    |        | GD218SF            |
|      |            |              | HAGER ELEKTRO AB<br>Box 9040<br>400 91 Göteborg<br>Tel:031-7063900 | HAGER STANDARDCENTRAL |       |        | Arb.nr<br>E2290839 |
|      |            |              |  |                       |       |        | Ritn.nr<br>3523G   |
|      |            |              |  |                       |       |        | Blad nr<br>1/1     |

# GD318S

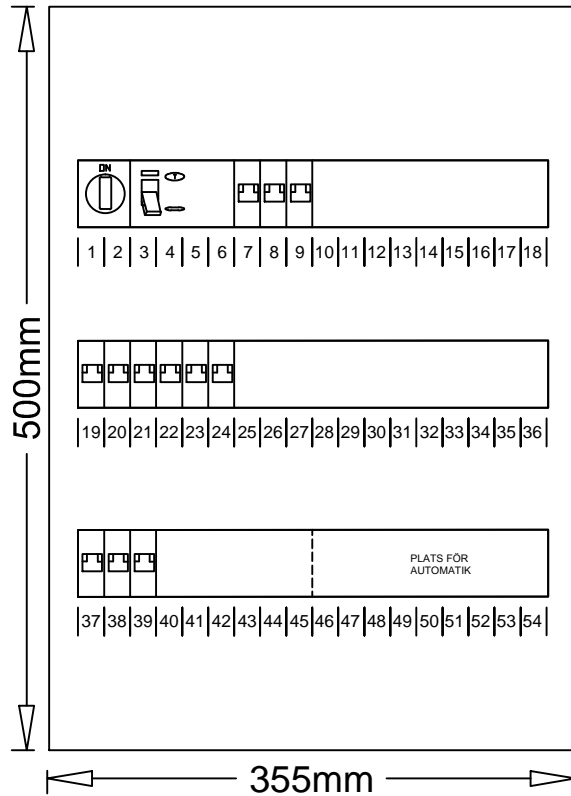

| POST  | TYP     |
|-------|---------|
| 1-2   | HA302S  |
| 3-6   | CDS425R |
| 7-9   | MCS110  |
| 19-24 | MCS110  |
| 37-39 | MCS110  |

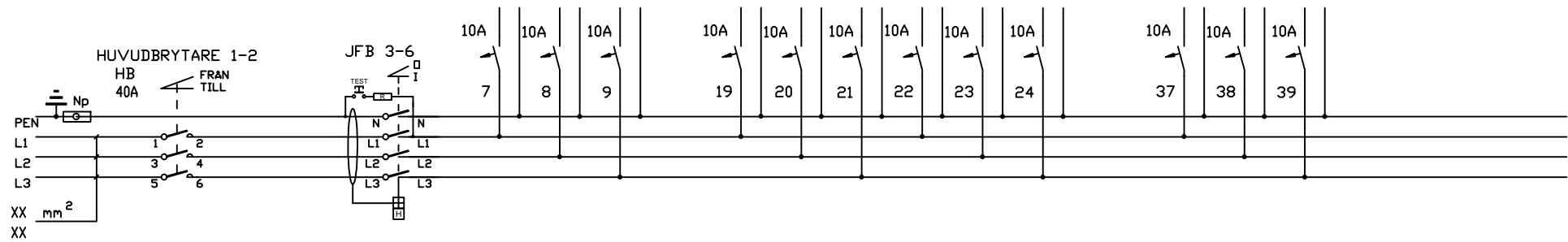

VID 5-LEDAR SYSTEM SKALL BYGEL MELLAN INKOMMANDE NOLLA OCH JORD DEMONTERAS

| Rev. | Datum      | Avser        | Datum  | Konstr.               | Ritad | Kontr. | Beteckning         |
|------|------------|--------------|--|-----------------------|-------|--------|--------------------|
| 3.0  | 2018-06-19 | ARTIKELLISTA | 2005-09-27   | MIKAEL HYLANDER       | MH    |        | GD318SF            |
|      |            |              | HAGER ELEKTRO AB<br>Box 9040<br>400 91 Göteborg<br>Tel:031-7063900 | HAGER STANDARDCENTRAL |       |        | Arb.nr<br>E2290840 |
|      |            |              |  |                       |       |        | Ritn.nr<br>3523F   |
|      |            |              |  |                       |       |        | Blad nr<br>1/1     |

# GD418S

625mm

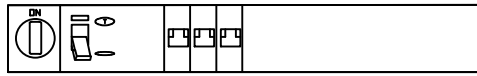

| 1 | 2 | 3 | 4 | 5 | 6 | 7 | 8 | 9 | 10 | 11 | 12 | 13 | 14 | 15 | 16 | 17 | 18 |

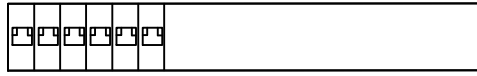

| 19 | 20 | 21 | 22 | 23 | 24 | 25 | 26 | 27 | 28 | 29 | 30 | 31 | 32 | 33 | 34 | 35 | 36 |

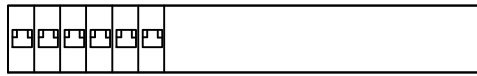

| 37 | 38 | 39 | 40 | 41 | 42 | 43 | 44 | 45 | 46 | 47 | 48 | 49 | 50 | 51 | 52 | 53 | 54 |



| 55 | 56 | 57 | 58 | 59 | 60 | 61 | 62 | 63 | 64 | 65 | 66 | 67 | 68 | 69 | 70 | 71 | 72 |

PLATS FÖR  
AUTOMATIK

| POST  | TYP     |
|-------|---------|
| 1-2   | HA302S  |
| 3-6   | CDS425R |
| 7-9   | MCS110  |
| 19-24 | MCS110  |
| 37-42 | MCS110  |

355mm

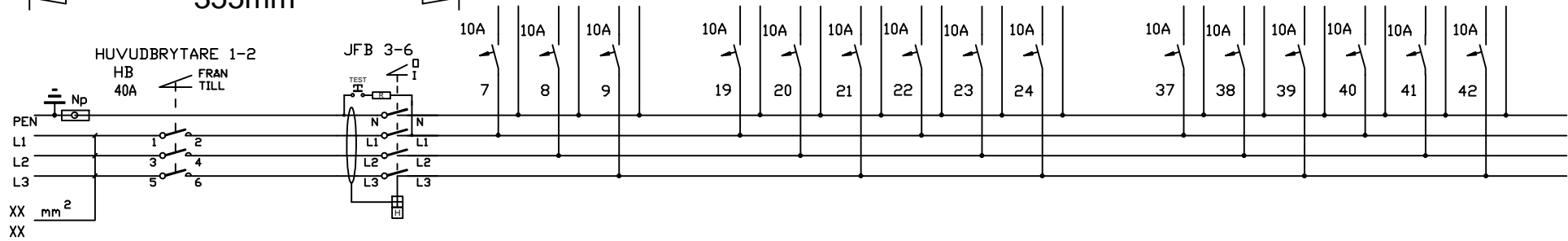

VID 5-LEDAR SYSTEM SKALL BYGEL MELLAN INKOMMANDE NOLLA OCH JORD DEMONTERAS

| Rev. | Datum      | Avser        | Datum  | Konstr.               | Ritad | Kontr. | Beteckning         |
|------|------------|--------------|--|-----------------------|-------|--------|--------------------|
| 3.0  | 2018-06-19 | ARTIKELLISTA | 2005-09-27   | MIKAEL HYLANDER       | MH    |        | GD418SF            |
|      |            |              | HAGER ELEKTRO AB<br>Box 9040<br>400 91 Göteborg<br>Tel:031-7063900 | HAGER STANDARDCENTRAL |       |        | Arb.nr<br>E2290841 |
|      |            |              |  |                       |       |        | Ritn.nr<br>3523E   |
|      |            |              |  |                       |       |        | Blad nr<br>1/1     |